

YOUR AMUSEMENT SOLUTIONS



Field Service

SUZOHAPP can provide service contract cover for your equipment or systems, supported by our field service team. Service contract customers have the ability to log calls with our service centre and receive on-site support, with all parts and labour charges covered, for a single annual fee.

No matter if you have a large number of our products, or just one odd note counter to count your daily takings, we can always offer you a suitable type of support.

We offer a range of support options, so let's go through your support needs together. It is possible you have some equipment that is crucial for your business, and therefore might need extra attention than the regular equipment. Our support options can be customised to fit your needs accordingly, which means that you will only pay for what you really need.

We specialize in Coin & Note acceptor reprogramming and Comestero Changer servicing. Perfect for:

- Users that operate equipment on a regular basis and need the equipment up and running
- Users that want an all inclusive support and service package



Table of Contents

LCD Video Topper	2	Lumia & Protec.....	37
Toppers.....	3	SCAN COIN Desktop Solutions.....	38
Rgb Topper Accessories	4	ICX Active-9	41
Rgb Ellipse Topper	5	Comestero Change Machines	42
Led Xenon Topper	6	Seating.....	44
Rgb Led Light Strip.....	7	Charge 'N Play.....	46
Led Topper Accessories.....	8	Background Music.....	47
Panels For Slot Machines.....	9	Coin Cups & Holders	48
Flexible Smd Led Light Strip.....	10	Redemption Tickets and Dispensers....	49
Adhesive Led Strip Lighting.....	11	Arcade.....	50
Lamps	12	Aerosols.....	52
Casino Chrome-Luminescent		Cues.....	53
Pushbuttons.....	13	Chalk & Tips.....	57
Joystick.....	18	Cue Cases.....	60
Custom Reel Mechanisms	20	Table Accessories	62
Power Supplies.....	21	Cue Racks.....	64
Flow Hopper.....	22	Pool & Snooker Balls.....	65
Evolution Hopper	23	Table Lighting.....	66
RM5 Evolution	24	Refurb Accessories	67
RM5 HD	25	Rules & Scoreboards.....	68
The Ideal Cashless Amusements		Cloth Cutting.....	69
Solution.....	26	Strachan	70
Innovative Technology	28	Eurospeed Cloth.....	71
Crane Payment Innovations.....	29	Superpro Speed Cloth.....	72
Cleaning Cards.....	30	Artscape™	73
Tito Tickets & Printer Rolls.....	31	Pool & Snooker Balls.....	74
Locks.....	32	Trolleys	75
Touch Monitors	34		
Monitors	36		

LCD Video Topper



- VGA or DVI connection
- RGB LED illumination, covered by an acrylic front plate
- RGB optional with or without controller
- Classic mini tower light chrome 2 lamps or 3 lamps or no mini tower light optional
- Black or chrome bezel
- Black feet included



103-020081101
103-0200011101

(chrome bezel)
(black bezel)

Please contact your sales representative for further information

Toppers



LED XENON TOPPER

104-07890SM



UPRIGHT TOPPER

104-01000



ELIPSE & MINI ELLIPSE TOPPER

104-05890 Ellipse
104-05890 Mini Ellipse



RGB TOWER LIGHT TOPPER

104-08000 Standard Colour
104-08000-AM AM Colour



ROUND TOPPER

1022XXX



ROUND VIDEO TOPPER

1042XXX

RGB Topper Accessories

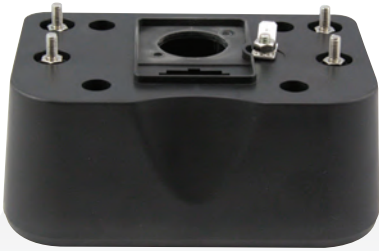

95-2862-00

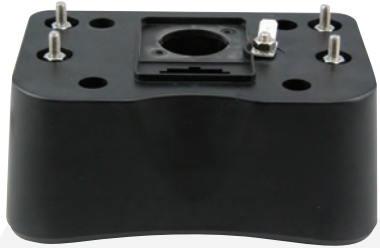

95-2863-00



95-2864-00



95-2865-00

Part Number	Description
-------------	-------------

95-2862-00	Topper Base for RGB Toppers, Flat
95-2863-00	Topper Base for RGB Toppers, Round
95-2864-00	Topper Base for RGB Toppers, Arch
95-2865-00	Topper Base for RGB Toppers, Slant

RGB Ellipse Topper



Pictured with Mounting Base & Tower Light
(Sold Separately)

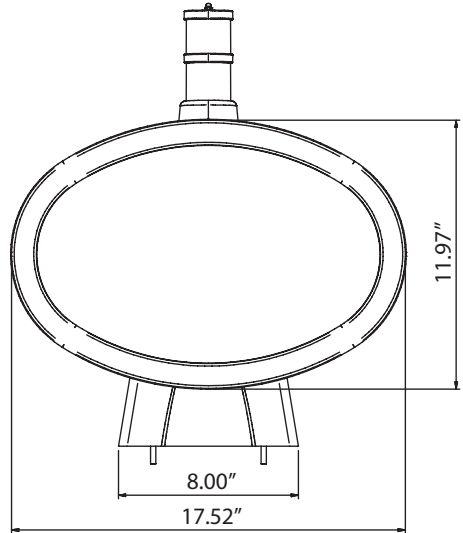

- On board PCB allows stand alone operation or synchronisation of up to eight topper boxes
- Up to 8 toppers can be synchronised using cables
- Toppers can be synchronised to create unique patterns, for example a snake pattern that runs from one topper to the next
- Seven pre-programmed flashing patterns
- Different attract modes including twinkling, full on, rotating left to right and right to left, flashing and more
- Ultra bright LEDs guarantee unequalled light output for a spectacular multi-coloured lightshow
- Backlit by 11Watt SL Lamp
- Translucent bezel contains 40 ultra bright nichia RGB LEDs for a multi-coloured light show
- Whole unit operates on 12VDC power
- Optional flat or radius mounting brackets with two mounting studs available to accommodate different cabinet configurations
- Body is constructed of black uL-94 VO ABS flame resistant plastic, color customisation available
- Tower Light and artwork panel not included

LED Xenon Topper

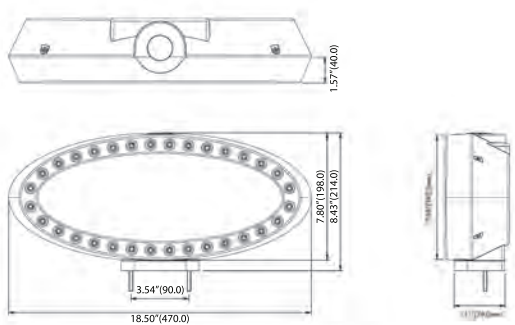

95-2846-00



104-0025

- Low profile to accommodate locations where ceiling height is a problem
- On board PCB allows stand alone operation or up to 8 toppers to be synchronized to work in a collective pattern
- Toppers can be synchronised using cables to create unique patterns, for example, a snake pattern that runs from one topper to the next
- Made of durable flame resistant uL-94 VO ABS plastics with chrome bezel
- Back lit by 11Watt SL Lamp
- Ultra bright LEDs guarantee unequalled light output for a spectacular lightshow
- Chrome bezel contains 32 bright LEDs
- Seven pre-programmed flashing patterns
- Different attract modes including twinkling, waves, fades and rollercoaster effects
- Whole unit operates on 12VDC power
- Optional mounting base (104-0025)
- Optional blank plexi panel (96-091500)
- Tower light optional
- Artwork not included

Part Number Description

Part Number	Description
104-07890	LED Xenon Topper (Can be Synchronised)
95-2846-00	Mounting Base for LED Xenon Topper for Round Top Machines
104-0025	Mounting Base for LED Xenon Topper for Flat Top Machines

RGB LED Light Strip



104-02000



104-02001

- Light strips with opaque bezel contains bright multi colour LEDs and when mounted to your cabinet they provide a dazzling light show
- Can be used by themselves
- When used with RGB Xenon Topper it runs from the topper box into the light strips and back
- Wire harness sold separately
- LED Light Strip Controller sold separately
- Light strip controllers provide seven pre-defined colour and seven pre-defined flashing patterns
- Can synchronise/link colour and flashing patterns between controllers and light strips (link cables sold separately)
- Controllers available for 20 LEDs or 40 LEDs
- +12vdc Operation



104-0062



104-0056

Part Number

Description

Part Number	Description
104-02000	RGB LED Light Strip - 20 LEDs
104-02001	RGB LED Light Strip - 10 LEDs
104-0062	Light Strip Controller - 40 LEDs
104-0056	Light Strip Controller - 20 LEDs
104-0054	Harness for RGB LED Light Strip - for one 20 LED Strip
104-0053	Harness for RGB LED Light Strip - for two 10 LED Strips

LED Topper Accessories



104-0020-1

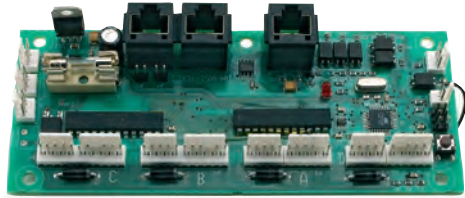

104-0051



9902-11



104-0001

Part Number

Description

104-0051	Topper Box Synchroniser
9902-11CW	Cool White Replacement Compact Fluorescent Lamp
9902-11	Warm White Replacement Compact Fluorescent Lamp
104-0020-1	Topper Mounting Base, Flat
104-0010-1	Topper Mounting Base, 15° Slant Angle
104-0015-1	Topper Mounting Base, 260° Curved for Round Top
104-0014-2	Topper Mounting Base, for Rio
104-0001	Tower Light Adapter Bracket

Panels For Slot Machines



Superior lighting technology now used in Gaming and Amusement Industry!

CUSTOM SIZES AVAILABLE

- No hot or cold spots
- Illuminates from the sides of the frame and creates a smooth full light without bright spots and shadows that occur with traditional back-lit panels
- Restore your older machines with a new, modern look
- Each model is engineered specifically for the exact application
- Low heat generation saves life of entire machine while significantly lowering air conditioning costs to casino floor
- Light PRO LED panels offer energy savings from 60-80%
- No mercury contamination to the planet and low carbon footprint
- Green energy efficient LED technology
- Available in three shades of white: Warm White, 3500K; Cool White, 5100K; Daylight, 6000K
- 5 year typical lifespan

Flexible SMD Led Light Strip

QL0089



Controller & wireless remote sold separately



QL0064-2



Attract More Attention and Increase Your Earnings!

- Easily installs in or around your machines to provide an updated look to draw more attention and increase earnings
- Great for amusement parks and games, casinos, slot machines, arcades, family entertainment centers, theaters, backlighting, decorative lighting, etc
- Ideal way to increase earnings on your cranes and pushers
- Very thin continuous length flexible LED light strips
- 5m rolls can be separated every 3 LEDs and reconnected again
- Super bright high-quality SMD LEDs per reel with 120 degree wide angle illumination
- 3M adhesive tape on back for easy installation
- Operates on +12vDC power supply (150-0072)
- Solid state, high shock or vibration resistant
- LEDs controlled by controller and wireless remote (sold separately)
- Each controller can run 65.62 feet (20 meters) of LED strips
- Long life: 50,000 hours
- Less power consumption than traditional lights
- No RF interference
- Sold in reels of 5m
- +12VDC; 20W

Adhesive LED Strip Lighting



Part Number Description

QL0019-1	5m Reel 300 LED Warm White Flexible 3528 LED Light Strip
QL0020-1	5m Reel 300 LED Cool White Flexible 3528 LED Light Strip
QL0021-1	5m Reel 300 LED Green Flexible 3528 LED Light Strip
QL0022-1	5m Reel 300 LED Blue Flexible 3528 LED Light Strip
QL0023-1	5m Reel 300 LED Yellow Flexible 3528 LED Light Strip
QL0024-1	5m Reel 300 LED Red Flexible 3528 LED Light Strip
QL0025-1	5m Reel 150 LED RGB Flexible 5050 LED Light Strip
QL0025-60	5m Reel 300 LED RGB Flexible 5050 LED Light Strip
150-0072	12VDC Power Supply, 5A
QL0064-2	Controller and Wireless RF Remote for RGB & Single Colour Light Strips

Lamps

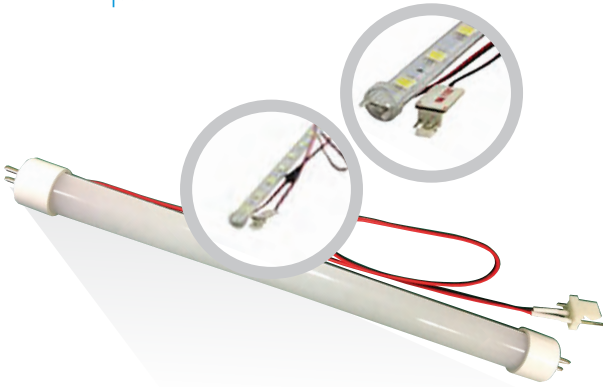

Light PRO LED Tubes

24V SMD LED Tube CW
Replaces Traditional Halogen F15T8

91-1017-00

24V SMD LED Fully Diffused Tube CW
Replaces Traditional Halogen F15T5

91-0858-00

5 mm

10 mm

161-212052	Red	161-212103-2	Red
161-212054	Yellow	161-212103-4	Yellow
161-212055	Green	161-212103-5	Green
161-212056	Blue	161-212103-6	Blue
161-212059	White	161-212103-9	White



CRANE/PUSHER LAMPS HALOGEN LAMPS OPEN

BAB	12v 20w
FMW	12v 35w
EXZ	12v 50w



GU10 BASE

12V 3W 9LED SMD CW
40,000+ Hour Life
X5109

Minimum order qty 20



GU10 BASE

Reflector lamp 240v/3w 80 LED
40,000+ Hour Life
X5098 (lots of 10)



SES LAMPS 60v 10w

#7965 (lots of 10)



MR16 BASE

12v 3w 60LED SMD CW
40,000+ Hour Life
X5093

MR16 BASE

12V 4 x1w LED
40,000+ Hour Life
X5018



Casino Chrome-Luminescent Pushbuttons



Large Square



Large Rectangle



Large Round



Small Square



Small Rectangle

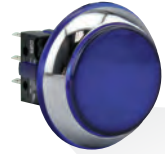

Small Round

Design Your Casino Chrome-Luminescent Pushbutton with the Matrix Below

RBM-730S- S C L
 | | |
 Size Color Luminescent
 Color, Bezel

S = Size

C = Lens Colour

L = Luminescent Effect

A = Large Square	2 = Red	2 = Red
B = Small Square	3 = Amber (Orange)	3 = Amber (Orange)
C = Large Rectangle	4 = Yellow	4 = Yellow
D = Small Rectangle	5 = Green	5 = Green
E = Large Round	6 = Blue	6 = Blue
F = Small Round	9 = White	9 = White

Nut Sold Separately, Part number RBM-K730-001

Casino Chrome-Luminescent Pushbuttons

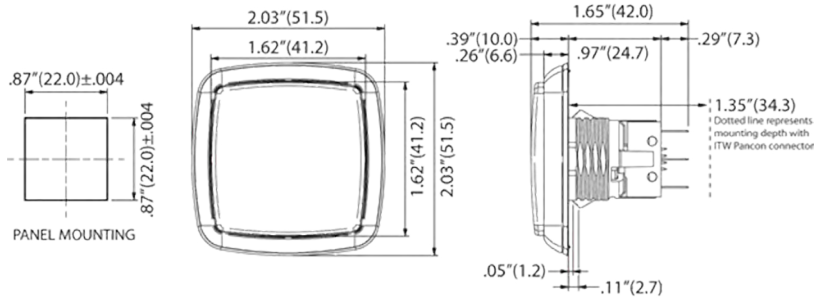

Large Square

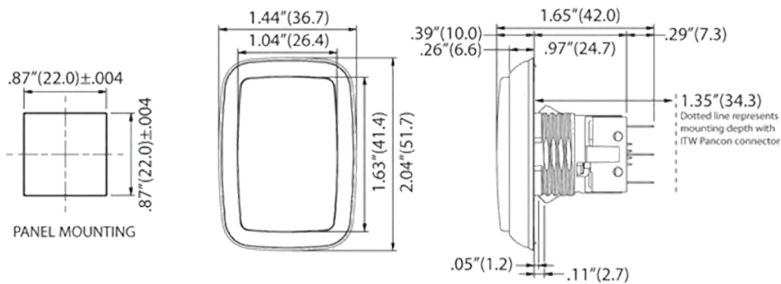

Large Rectangle

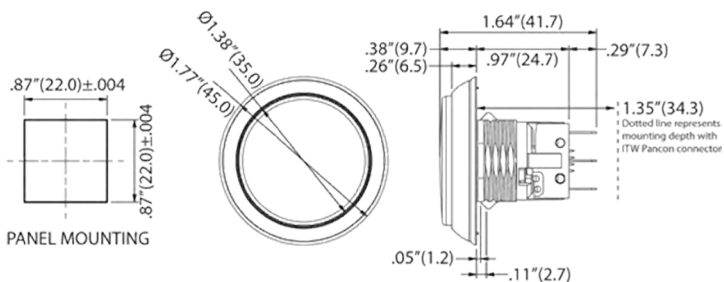

Large Round

Casino Chrome-Luminescent Pushbuttons

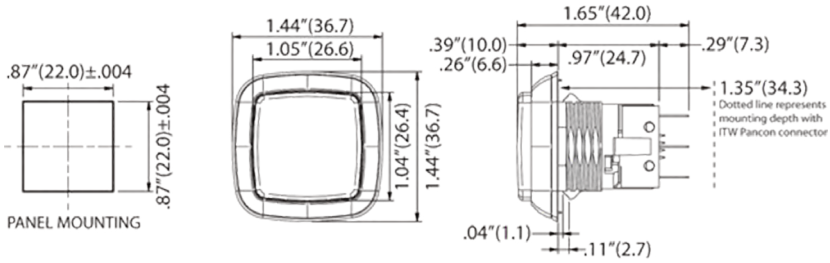

Small Square

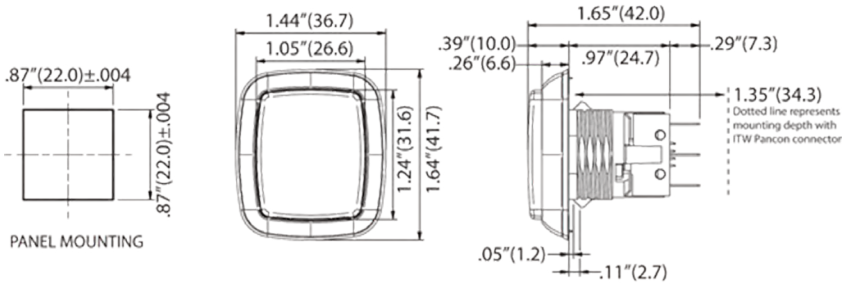

Small Rectangle

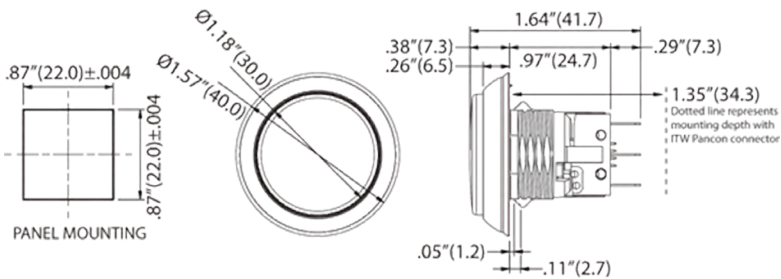

Small Round

Communication Protocol Controlled Lighted RGB Pushbutton



Features

- Coming with magnificent lighting effects
- 13 different display modes to control. Enhance user interaction for your machine
- Top quality with a competitive price
- Use the IC and LED with high quality and long life
- Simple installation takes your machine assembly to the next level
- Available in different colours



RGB Illuminated Pushbutton (Large)



RGB Illuminated
Pushbutton (Small)



RGB Illuminated
Pushbutton (Medium1)



RGB Illuminated
Pushbutton (Medium2)

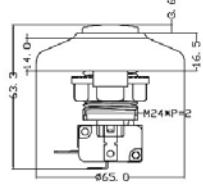
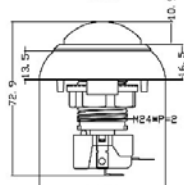
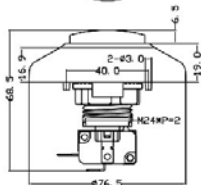
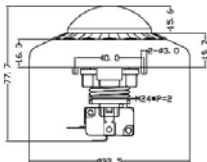
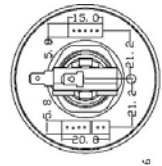
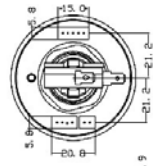
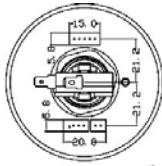
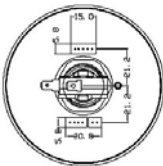

10202070-(non-programmable)
10202071-(programmable)

10204050-(non-programmable)
10204052-(programmable)

10204051-(non-programmable)
10204053-(programmable)

10205060-(non-programmable)
10205061-(programmable)

RGB Controllable Pushbutton



Features

- Built-in RGB LED PCB. It can be controlled by LED driver with constant current output
- Built-in microswitch
- Made with highest quality raw materials
- Suitable to be used for various machines
- Over 10 million times reliability test for microswitch with gilded contact legs
- Button size options: 24 mm, 28 mm
- Connection options: 6pin connector, 110" terminal



24mm



28mm

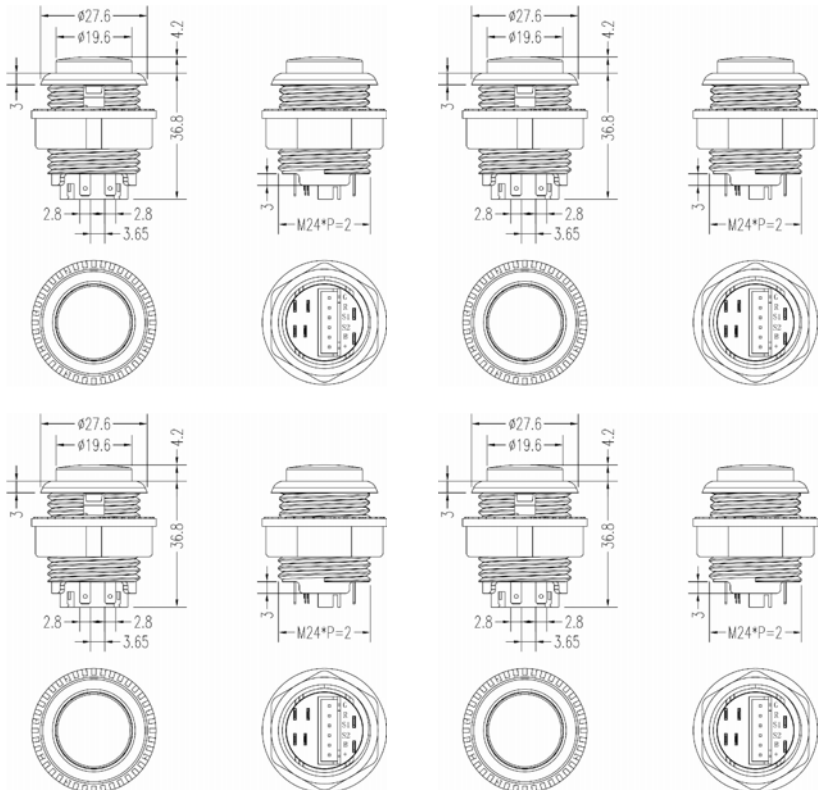

New Concave Round Pushbutton



Features

- Special anti-scratch material. With stunning flashing vehicle baking finish appearance
- Built-in microswitch
- Top quality with a competitive price
- Suitable to be used for various machines
- Over 10 million times reliability test for microswitch with gilded contact legs

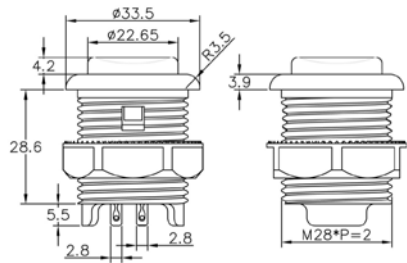

BL Locking Style Joystick

Features

- Unique and very attractive round diamond knob design
- Shaft Locking design, easy and quick for installation
- New Shaft design for switchable Knob and anti-stealing functionality
- Special switch/PCB locking design, convenient for service and maintenance
- Made with highest quality raw materials with a competitive price
- Connection types: Switch only, switch with PCB
- Special lighted design (non-lighted model is available)
- Knob options: 43mm diamond ball with bubble, 43mm diamond ball without bubble, 35mm solid round ball (red /black)
- Suitable to be used for various machines



Switch structure



Switch with PCB



Switch with PCB and LED light

BL Spinner



Features

- Whole metal structure, High durability
- Moisture-proof plastic cover design
- Built-in automatic RGB LED lighting effect
- Made with highest quality raw materials
- Suitable to be used for various machines



Square LED Pushbutton With Double Colour Body

Features

- Two color design. Unique and very attractive appearance
- Built-in lighting LED design with 110 terminals; Long life and easy to use
- Built-in microswitch
- Suitable to be used for various machines
- Over 10 million times reliability test for microswitch with gilded contact legs

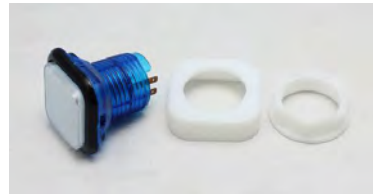

Custom Reel Mechanisms



Custom Engineered Reel Mechanisms to Fit the Needs of Our Customers

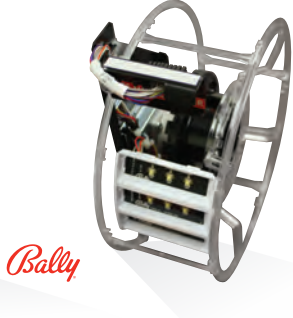
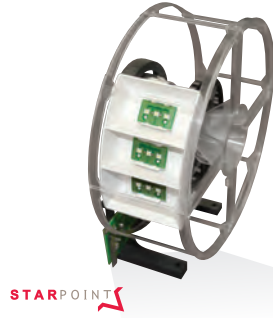

Contact a SUZOHAPP Sales Representative to see how we can work with you to develop a product solution for your gaming machine.

Power Supplies



200W UL POWER SUPPLY

- +5v 20A, +12v 8A,
- -5v 0.5A, -12v 0.5A
- UL Recognized
- 200 watts of power
- Dual AC Input 115vac/230vac, selectable by jumper
- 1 year warranty

80-1152-00

Power PRO POWER SUPPLY

- Industry standard
- High efficiency
- Easy Start up
- Green 'Power on' LED
- Overload protected
- Built in EMI filter
- Maximum noise minimisation
- Weight 0.8Kg/ 20 pieces in box

42PP0606 spec +5v , +12v and -5v
42PP0608 spec +5v , +12v and +24v



DUAL SWITCH AND REMOTE CAPABLE 200 WATT POWER SUPPLY

- +5v 20A, +12v 8A, -5v .5A, -12 .5A
- UL and CSA Recognized
- 200 Watt power supply
- Great power supply for video games & video poker applications
- New Innovative Dual On/Off and Remote switch capable design.
- Additional 8 Circuit Molex plug with +5vdc and +12vdc outputs for additional accessories
- Dual AC input 115vac/230vac, selectable by switch
- AC plug for hook-up of Bill Validator, 110vac 1.0A
- Physical Size: 3-1/2" H x 5-7/8" W x 5-1/2" D
- Supplied with 6' long SJT power cord
- 1 Year Warranty

80-00002-10



POWER SUPPLY

12V 5A 2.5mm (Level 6) 1m lead
150-0072



Flow Hopper



Large Cup



Intermediate Cup



Medium Cup

New and innovative through hole hopper!

- Perfect for many applications including Amusement, Vending, Gaming, Parking and Change machines
- Constructed of extremely durable, wear resistant plastic along with state-of-the-art electronics
- Available in six interfaces:
 - Parallel
 - Pulse
 - ccTalk
 - DES
 - AES
 - SCH3
- Supplied with quick-fit release plate

Features

- Compatible with other popular hopper devices
- Payout speed of up to 7 coins per second
- Three different bowl sizes available – small, medium and large
- Reliable through hole coin disk design
- Clean design – no external wires run for level sensors
- Integrated fall tube for simple dual hopper cabinet construction
- ccTalk version is available in encrypted and non-encrypted modes
- Parallel interface and standard 10-pin connector
- 12-24V power supply
- Continuous opto-sensor check
- Low level sensor and anti-jam feature

RBM-712 I - D C

Interface Coin Cup Size
Payout Disc

Evolution Hopper

The Evolution Hopper is a great extension to the Hopper line of SUZOHAPP. This belt driven hopper has been re-engineered and the result is an improvement over existing belt driven hoppers in its performance and maintenance. The unique concept provides a single build type hopper that is suitable for 95% of world's coins and tokens without needing adjustments.

The Evolution Hopper is suitable for many applications such as: Vending, Parking, Change, Amusement and Gaming machines. Made from extremely strong, wearing resistant plastics in combination with state of the art electronics resulting in low cost of ownership.

Large DC motor in combination with electronic motor control board for reduced friction and motor noise. Optic board is easily accessible by removing the electronic control board from outside the hopper.

Connector can be easily changed from front to back by just loosening two screws and pulling the cable with connector in its position (reduced inventory for manufacturers that use both styles). Standard parallel interface.

Features

- Modular space –efficient system
- High capacity >1100 coins of 1 Euro
- Pay out speed 4 coins per second
- Built-in agitator to prevent coin jams
- Protected by anti-jam electronics
- Large motor reduces motor noise
- High quality materials for long trouble free operation
- Easily removable and accessible electronics
- Hopper connector can easily be changed from front to back
- Low and high level sensing
- Competitively priced
- Low cost of ownership



EVO1000

RM5 Evolution

Coin Validator



The RM5 Evolution coin validator is known for its undisputed quality and reliability. Its electronics combine extraordinary selectivity with extreme programming versatility: the Cloning system allows the transfer of the configuration parameters from one sample coin validator to another.

Features

- 3 pairs of inductive sensors which are used to process 6 different parameters regarding the material and the mass
- 3 pairs of optical sensors to determine coin's diameter
- A mechanical anti-fishing device
- An electronic anti-fishing device
- An electronic anti "intrusion" device (only for version F)
- Wire cutting blade
- Automatic optical sensor compensation system for variations in temperature, voltage and lighting
- Identification channels: up to 59, each of them can be redirected to the outlets. The first 6 support Self-Prog mode
- Open collection outlets
- Serial interface for external connections (portable programmer or PC) for calibrating and testing, as well as for updating the value and operating parameters tables
- Credit recognition: parallel, binary, pulse
- Also available in tropicalised version to be used in environments affected by adverse weather conditions



Programming kits

PC Based

RMPRKIT5 (Evolution)

Handheld

RMPRCHRM5STARUK (Evo)

RM5 HD

Coin Validator



Coin validator equipped with HD high discrimination system. 3 types of sensors and 10 coin validation parameters. Advanced electronic and mechanical anti-fraud system.

Features

- HD high-discrimination system based on 10 different parameters regarding: frequency, dimensions and phase
- 5-sensor identification technology: 3 inductive sensors, 1 optical sensor and 1 magnetic sensor
- High acceptance speed: 6 coins per second, even of different values
- Compatible with all coin sorters available on the market
- Advanced electronic and mechanical anti-fraud system: electronic antifishing device, coin movement direction detection, 3 mechanical traps, and wire cutting blade
- Indicator LED



Programming kits for RM5

PC Based
CRMPRKITHD (HD)

Handheld
CRM-DIP (HD)

The IDEAL™ Cashless Amusement Solution



IDEAL Cashless System uses debit cards for games, attractions and other purchases

Increase revenue by going cashless!

Customers tend to spend more when they don't have to make a buying decision each time they play a game or choose an attraction. Incentivise a larger up-front purchase by allowing your guest to load up a debit card that can be used anywhere in your facility, including any Point-of-Sale location. Ideal makes it easy and operations become much simpler.

You get more ways to drive business, including Time Play, Lock Ins, and Packages. Check out the different elements of the Ideal Cashless System, including Game Card Readers, Access Control Enclosures (for use with or without turnstiles), and Kiosks (automated card purchase/recharge stations).

Benefits of the ideal Cashless System increase revenue

- Customers spend more up front
- Customers play more freely once value is on the card

Flexibility

- Set prices in smaller increments than a quarter
- Adjust prices automatically in peak/off peak times
- Entitlements let you give rights to certain attractions
- Packages can be loaded on cards with entitlements and cash
- Supports free play, time play and discounts
- Supports cashless food and beverage service at POS locations
- Cash controls are absolute - cash added is accounted for

Actionable Reports

- Extensive reporting by site or by attraction
- Receive revenue snapshots via email or access on your phone

IDEAL Self Service Kiosks

Kiosks that sell cards and add value using cash, coin, or credit card, and register cards and show history. Ideal kiosks increase sales while simultaneously reducing labour costs. Increase your income by offering customers a self serve, always available means of purchasing or recharging game cards.

Ideal kiosks can be themed with custom graphics to compliment your facility's overall look and feel. It uses a large touch-screen colour display for the best guest experience. It accepts notes, coins (optional) and credit cards. It even prints receipts. The Ideal kiosk not only sells and recharges cards, but also allows you to view your purchase/play history, register your card (adding customer data to your marketing database), and can be configured to sell attractions and packages.

IDEAL RFID Bands

Radio Frequency Identification Device

Dramatically increase the efficiency and security of any type of amusement facility by taking advantage of the benefits that RFID can provide for cashless point-of-sale, vending, access control and other guest applications. Ideal Software Systems is the choice to help your business take advantage of this technology.

The benefits of RFID are obvious: no card, ticket or wallet is necessary for customers to have full access to ALL of the amenities in your facility.



IDEAL POS

Simply the Most Complete Amusement Business Point-of-Sale System Available

- Cashless Card System
- Redemption
- Online Event Registration
- Party Scheduler

Ideal POS is the most user-friendly and versatile software programme in the amusement industry today. Ideal pioneered the use of software to manage and operate Family Entertainment Centers (FEC) while developing and installing the first systems in 1983. We had installations long before others were even in the industry. Ideal POS is the foundation for your One Ideal Solution™.

To build your complete One Ideal Solution™ to manage your entire facility, we offer the most comprehensive set of software modules (e.g. Party-Scheduling, Redemption, Debit Card System, Capacity Management, eCommerce, Bowling, PDA Apps, etc.) that integrate seamlessly with your Ideal POS.

From the get go, you will never have to worry about outgrowing your current system or needing any other system as Ideal will have the best solution for your current and future business needs. Being a software company, Ideal continually invests in its software R&D and partners with industry-leading software vendors (e.g. PCCharge and TimeClock Plus) to offer you the best of breed and industry-changing solutions.



IDEAL RCM

Redemption Center Manager

Ideal Redemption Center Manager (RCM) moves customers quickly and efficiently through the redemption area, solving one of the biggest challenges in any Family Entertainment Center (FEC). Ideal RCM dramatically improves customer service at the redemption counter by enabling up to 4 attendants to effectively serve up to 15 customers at one time. Ideal RCM has the most complete inventory software on the market along with advanced control features. Ideal RCM reduces labour costs while eliminating long queues and confusion at the redemption counter. In addition, Ideal RCM helps operators supervise and manage receipts, internal transfers, redemption, refunding, and inventory reporting of inventory.



Benefits of Ideal RCM

- Maintains vendor information
- Automatically calculates points values
- Guests can bank unused points into their own personal savings account or receive a bar-coded voucher for future use

Control

- Integrates with scales and ticket eaters
- Electronic inventory and processing controls

Actionable Reports

- Provides re-order reports based on sales history
- Anyone can generate actionable reports



SMART HOPPER

The Smart hopper from Innovative Technology brings coin payment technology into the 21st century. Ideal for all machines, the Smarthopper eliminates the need for multiple hoppers, sorters and reduces the cost of handing coins internally.



DA3 KIT

DA3 Validator Programming System for use on-site / in the field.



NV200

The NV200 bank note validator accept bank notes up to 85mm wide and standard industry bar codes. The NV200 is a secure and filed proven bank note validator. With a lockable, removable cashbox that can hold up to 100 notes, and add on recycler unit (Smart Payout) is available to allow mixed denomination note recycling.



NV9 USB+

The NV9 USB+ has been developed to incorporate programming via a configuration button or configuration card and includes USB capability and advanced note guidance technology.



NV10 USB+

The NV10 USB+ has been developed to incorporate programming via a configuration button or configuration card and includes USB capability.

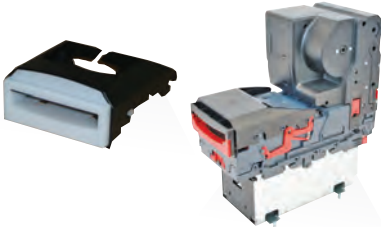

NV11+ NOTE FLOAT

The NV11+ is the latest model from Innovative Technology, incorporating a bank note validator and 'Note Float' payout unit. With a 30 note capacity of one single denomination, the NV11+ is capable of dispensing notes as change or prizes, helping to relieve the possibility of coin starvation and keep machines running.



NV12+

The NV12+ is a revolutionary compact validator and ticket printer that dramatically reduces operational costs by eliminating hopper starvation and reducing cash handling tasks.

Crane Payment Innovations



NRI v² EAGLE

The v² eagle coin validator is setting standards within the payment systems industry. By using the unique MFT validation technology and additional sorting control sensors, outstanding coin security is guaranteed. The v² eagle is fully compatible with Money Controls SR5i applications and all NRI G-40 applications.



HEARTBEAT/WINEAMP

Programmer



COMPACT HOPPER

The Compact Hopper does exactly what the name says, providing a large capacity with a small footprint. This makes it ideal for many applications including retrofit. The Compact range offers high security and high speed for single denominations.



v² COLIBRI

The v² colibri is Crane Payment Solutions newest 3.5" coin validator. With input from the NRI and Money Controls brands, this validator offers best-in-class MFT coin validation technology for the highest coin security and is compatible with all SR3i and NRI G-13 applications.

Cleaning Cards



Note Acceptor
Cleaning cards

29-0329-20

Card Reader Cleaning cards

29-0329-10

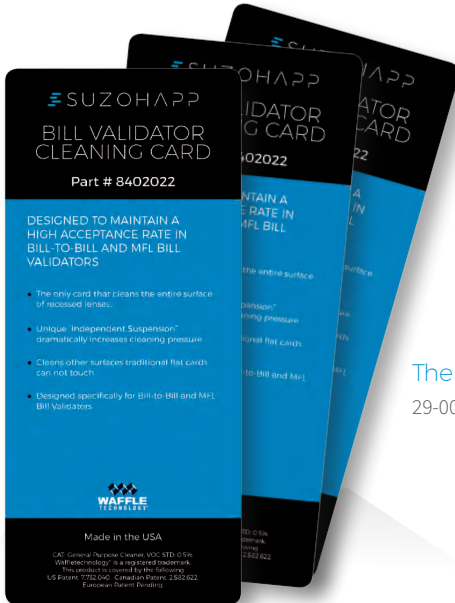

Thermal Printer Cleaning cards

29-0005-00

TITO Tickets & Printer Rolls

Available in stacks of 200, 400, 600

THERMAL PAPER

SUITABLE FOR TICKET EATER
80 x 80 Thermal Paper 12mm Core
20 per box

THR0003

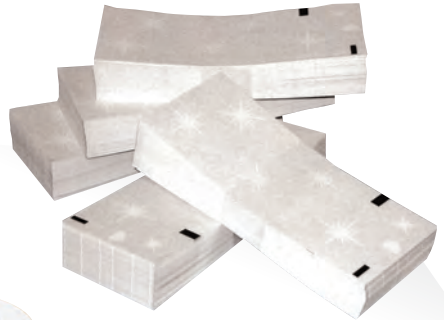

TITO TICKETS

TI00015 (200)
TI00014 (400)
TI00006 (600)

CAN BE PERSONALISED

THERMAL RECEIPT PAPER

For Benchmark Ticket Eater

54-PAP003-01



ATM Till Roll

146-0167-1



ASSA DESMO LOCKS

The World's largest manufacturer of locks, ASSA has developed the Assa Desmo as its top of the range camlock product. With many of the world's largest casino groups as customers, the product has become a standard of any casino operator who insists on maximum security combined with maximum operating comfort. The launch of the RC (removable core) version has made this line complete; the casino has now both maximum security and economic handling in one product. Assa Desmo is a patented lock construction based on direct drive pins (no spring operation) making it particularly suitable for dirty conditions and hostile environments. False cuts on the pins provide resistance to any currency known method of picking. A large key made from nickel silver provides many years of guaranteed comfortable handling. The Assa Desmo system is the most effective way to prevent unauthorised manufacturing, cutting and distribution of key blanks. It also requires the most advanced and precise cutting equipment in the lock industry. No Key blank for Assa Desmo are sold and key production for Europe is only done in Sweden.

Features

- 8 pin lock combined with two strong side bars (6 pin for RC series)
- Patent protected against unauthorised key duplication
- False cuts on the pins provide resistance to any currently known method of picking
- Large key made from nickel silver for lasting durability and comfortable operation
- Standard 90° operation and key removable in locked position, optional available with removable key in either locked or unlocked position
- Various collars available to adjust the mounting depth
- Switch locks available in the same keycode as standard camlock
- Supplied with standard 32mm cam. Other sizes and models available

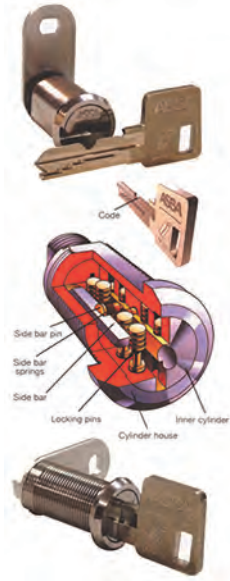

GEMATIC LOCKS

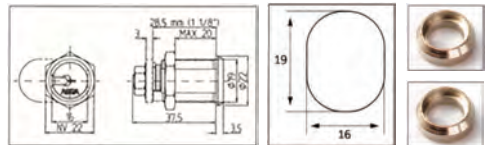

Gematic locks are available in sizes:
 16mm (5/8"), 22.3mm (7/8") and 28.6mm (1-1/8")
 Sold in minimum quantities of 50 Complete with 5 sets of keys

- F8GS1058 Gematic lock 16 mm (5/8")
- F8GS1078 Gematic lock 22.3 mm (7/8")
- F8GS1118 Gematic lock 28.6 mm (1-1/8")



Locks & Security Bars

SWITCH LOCK

10 pin operation lock with 2 keys

- 10 pin operation
- Die cast housing with chrome finish
- Length 36.4 mm (1-7/16")
- Large key provides good grip during operation Key made of nickel silver material for trouble free performance
- Switchlocks have 6.3 x 0.8 mm terminals fitted for easy connection
- Key different locks are supplied with 2 keys per lock
- Switchlocks are available with or without automatic key return



MINI BAR HASPS

Standard 4-1/2" Mini bar Hasp
30-1006-00



22-0911

ADJUSTABLE SECURITY BAR

- For Changers, small Cabinets and other games
- Adjustable from 25 to 40 cm
- Easy installation
- Made from durable steel with black finish
- Simple mounting with provided hardware
- After installation, only a 12 mm hole needs to be drilled in hasp to fit padlock (not included)

UNIVERSAL SECURITY BAR

- Designed to be used with a padlock (not included)
- Heavy duty steel
- Telescopic adjustable 40 - 85cm
- Supplied complete with hardware
- Not recommended for pedestal cabinets



Adjustable Security Bar

22-0912

Specially designed for all types of Coin Operated equipment

Touch Monitors



Brilliant Display. Superior Quality. Competitive Price.

Engineered and designed specifically to perform in some of the most demanding, high-touch environments, the 90-Series open-frames feature touch technology that is built-in rather than bolted-on. Enjoy unsurpassed quality and reliability in any setting-at an attractive price point!

- Wide range of sizes-from 10" to 27"-to fit your environment
- Next generation Projected Capacitive (PCAP) 2GS (two glass solution) technology delivers both a ten touch "tablet like" interactive experience along with thru-glass functionality both modes support single or dual latex gloves as well as cloth gloves and provide durable performance in high traffic settings
- Projected Capacitive (PCAP) units pass UL Ball Drop test and IK07
- Purpose-built, open-frame architecture for hassle-free installation and cable management
- Common electronics and mechanical design across all sizes including VGA, display port, serial, USB type B, RJ45 - OSD remote controller
- Drop in replacement with backwards compatibility allows for plug-and-play replacement of existing units – (X,Y dimensions and mounting are the same as current products – Z dimension are the same or thinner)
- Seamless, edge-to-edge glass touch displays provide modern, true flat designs without compromising brightness, optical clarity or response time
- LED back-lighting reduces power consumption and creates slimmer designs



Upgrade Your Current Open-Frames to the NEW90-Series

Compatibility Information:

2243L	replaced by 2293L
2240L	replaced by 2494L
2470L	replaced by 2794L



2794L 27" Open Frame Touchscreen

Aspect ratio	16:9
Contrast ratio	3000:1
Brightness (panel)	300 nits
Viewing angle	89°/89° or 178°/178°
Native resolutions	1920x1080 at 50, 60Hz
Touch technologies	Projected Capacitive (PCAP), IntelliTouch SAW, IntelliTouch Plus SAW

2293L 21.5" Open Frame Touchscreen

Aspect ratio	5:4
Contrast ratio	1000:1
Brightness (panel)	250 nits
Viewing angle	85°/80° or 170°/160° 1280x1024 at 60Hz
Native resolutions	1920x1080 at 50, 60Hz
Touch technologies	Projected Capacitive (PCAP), IntelliTouch SAW, IntelliTouch Plus SAW

SUZOHAPP carries more LCD Monitors IN STOCK than all of our competitors combined



CUSTOM LCD / TOUCHSCREEN SOLUTIONS

- 15" / 17" / 19" LCD MONITOR
- Units work in CGA, VGA, SVGA or XGA resolutions
- Ideal for use in most Amusement applications
- Replace your old outdated CRT monitors with a Vision Pro LCD and give your games a new modern look

Lumia & Protec

Available with Charge'N Play

'LUMIA' RGB INFILL PANEL

Features

- Pleximilchglas with RGB LED lighting and remote control
- High quality soldering iron stand
- Front panel can be easily removed (3 screws). Different colours adjustable, as well as various flash modes and a colour change programs
- Very discreet, non-glare lighting
- Dimensions: 95cm x 35cm x 47cm

30-0010RGB

PROTEC Alarm System

Features

- Easy Installation
- 12/24v DC operation
- Battery Back up
- Uses accelerometer - no external Tilt Switch necessary
- Automatic arming (if required)
- Suitable for all Amusement, Gaming & Change Machines
- External LED indicator
- Spares available upon request

189-1000 Protec Alarm system

189-0204 Relay for Protec Alarm

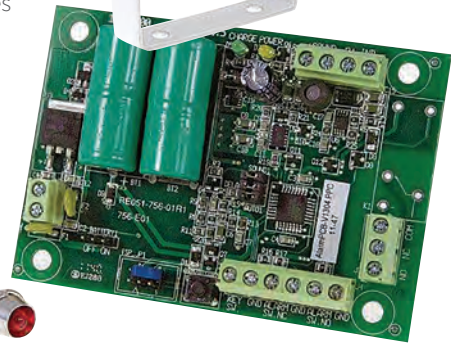

SC-8220 NOTE COUNTER

- 1.5 Pocket Value & Multi Currency Counter
- The SC-8220 comes with a preset of around 20 currencies
- Counts total mixed notes
- Multi Currency mode
- Detects counterfeits
- External UV lamps



SC-1600 SERIES

- Counts up to 1,500 notes per minute
- Available in different security levels and note recognition modes (UV, MG, IR, 3D)
- Also available as SC-1610 Euro Value (ECB approved)
- Small footprint and handle makes it easy to place in many environments
- Can be connected to the software for further data handling



DTC-1

- Compact and light value counter for mixed coins
- Counts up to 32 different coins with dual currency option
- Easy operating and maintenance that require very little training for operators
- Equipped with sensor technology
- Optional dual currency mode
- Can be connected to the software for further data handling

DTC-9

- 9 pocket value sorter for mixed coins
- Counts up to 32 different coins with dual currency as option
- Easy operating and maintenance that require very little training for operators
- Equipped with rail sorting technology which makes the machine extremely easy to upgrade (for example for coin reforms)
- Equipped with the sensor technology
- Can be connected to the software for further data handling





SC-303

- Compact, silent coin counter (up to 2,700 coins per minute), ideal for banking, retail and amusement
- Counting, bagging and tubing
- Pre-programmable batch stops
- Handle for easy transportation
- Easy to read led display

SC-350 / SC-360

- Coin counter ideal to fit the gap between heavy duty machines and smaller back-office machines (counts up to 3,000 coins per minute), ideal for banking, retail and amusement
- Equipped with standard RD/AuX for external display and foot control and serial interface for possibility to control machine from PC
- Counting, bagging and tubing
- Pre-programmable batch stops
- Easy to read led display
- SC-360 has a standard hopper for 6 litres of coins



When Speed and Accuracy Matter

An exciting contender to make an entrance into the cash solution 'ring', the ICX Active-9 is perfect for medium sized businesses, especially those wishing to process medium volumes of coin without having to worry about reliability and capability.

Features

- Process multiple currencies
- Adding multiple coins in the same bag
- Bag switching
- Multiple set-ups
- Configured in software
- Highest throughput and efficiency

For Medium Coin Volumes

It is a competitive mid-range coin solution for customers who receive a reliable, robust machine, but also benefit from fantastic value on investment.

The ICX Active-9 is the perfect solution for customers who manage medium volume of coins, but need the reliability and outstanding features of the ICP Active-9.

Latest Design With Proven Best-In-Class Technology

This new design is developed through listening to our customers and adapting to match their needs. Furthermore, the solution has a 10" LCD touchscreen display for quick operation where the user can easily change the set-up of denominations and keep track of the cash management data in order to develop their business further.

The ICX Active-9 features the same firmware as the strong ICP Active-9 platform with the unique, software-controlled Active Sorting® technology. It has the ability to re-program sensors which provides the intelligence necessary to instantly adapt to future regulatory needs without having to invest in new hardware.



Key Product Features

- Basic dimensions (WxDxH*): 770 mm x 614 mm x 547 mm (30.3" x 24.2" x 21.5")
- Active Sorting®
- 9 coin outlets plus 1 for rejection
- Processing up to 2,700 coins per minute
- 10" touchscreen user interface
- Low power consumption
- Either desktop or standalone solution
- 3 USB for accessories or peripherals
- One ethernet port for networking
- Additional input and output for accessories
- Coin outlets are spaced identically to the ICP Active-9 and SC-4000
- Configuration by standard P-5000 service program

SWING

Solid and compact coin/banknote change machine. Free standing armoured cabinet. Refill key. SD-card for programming, upgrading fw and exporting accounting data. Coin capacity: 3,000 1€ coins

Banknote capacity:
70 (in the recycler) + 500 (in the cashbox)



SMART EASY

Coin change machine equipped with multi-coin hopper. Accepts up to 6 coin values. It can be installed on a base, on a support countertop or wall-mounted.

SD-card for programming, upgrading fw and exporting accounting data.

Coin capacity: 3,000 1€ coins

BRAIN

Thanks to Brain, one or more machines may be networked and remotely controlled via PC or tablet and notifications can be received on your smartphone. With a simple connection, you can access all the information concerning on board accounting, alarms and the master data you manage.





EASY PRO

Compact coin change machine. It dispenses one type of coin/token. It can be installed on a base, a countertop or wall-mounted. SD-card for programming, upgrading fw and exporting accounting data.

Coin capacity: 2,400 1€ coins



TWIN JOLLY PRO

Sturdy and reliable coin change machine. It dispenses two types of coins/tokens. Free standing cabinet. SD-card for programming, upgrading fw and exporting accounting data.

Coin capacity: 6,800 1€ coins



DUAL COIN PRO

Sturdy and capacious coin change machine. It dispenses two types of coins/tokens. It can be installed on a base, on a support countertop or wall-mounted. SD-card for programming, upgrading fw and exporting accounting data.

Coin capacity: 7,000 (1€) coins



JOLLY PRO

Slim and versatile coin change machine. It dispenses one type of coin/token. Free standing cabinet. SD-card for programming, upgrading fw and exporting accounting data.

Coin capacity: 3,400 1€ coins

Seating

ZENITH

ADJUSTABLE HEIGHT SWIVEL CHAIR

- Eco leather fire-retardant, water-proof, stainproof (certific 300,000 cycles anti-abrasion)
- Padded ergonomic polyurethane foam to varying hardness
- Base: chrome diam.500 mm conical reinforced steel
- Swivel and up & down 58 cm to 84 cm (suitable for both slant top and high cabinet both)
- Base is 55 diameter - maximum height of backrest is 103 cm (minimum) and 128cm (maximum)
- Seat Auto-return 360 degree with auto-centring breaking friction
- Finished chromium
- Exceeded the following tests and certifications: durability test, seat and back drop test, footrest fatigue resistance, resistance to fatigue armrest, stability test



ZENITH4

- Eco leather fire-retardant, water-proof, stainproof (certificate 300,000 cycles anti-abrasion)
- Padded ergonomic polyurethane foam to varying hardness
- Base chromed steel in 4 legs
- Finished chromium
- Exceeded the following tests and certifications: durability test, seat and back drop test, footrest fatigue resistance, resistance to fatigue armrest, stability test



Seating

The Carrillo

- Eco leather fire-retardant (certificate 300,000 cycles wear resistance)
- Padded ergonomic polyurethane foam to varying hardness
- Structure in reinforced steel with welding anti-break
- Finished chromium (three chromium)
- Available in height 73 cm for high cabinet or 55 cm idea for slant top
- Exceeded the following tests and certifications: durability test seat and back - drop test - footrest fatigue resistance resistance to fatigue armrest - stability test



Available in two sizes

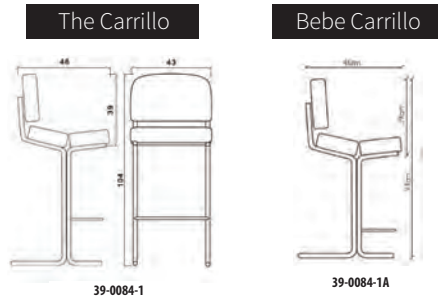

PERSONALISED ARTWORK AVAILABLE



APOLLO

- Free running backrest
- 360° rotation
- Adjustable seat height
- Spare parts available

Height of backrest	34 cm
Seat depth	49 cm
Seat width	51 cm
Seat cushion	11 cm



Dual USB Car Charger



Top or Side Mount Module



Dual USB Charger Socket

Charge 'N Play

96-2320-00

Dual USB Charger Socket

96-1503-00

Top or Side Mount Module

92-2478-00

Dual USB Car Charger

Power

X9103

Power Loom w/o Connector

X9104

Power Loom with DC Connector

150-0072

12v DC PSU

Accessories

H04 001

Marketing Wobbler



Marketing Wobbler with adhesive base

Background Music

Audio Solutions



SAS1



SAS2



SAS3

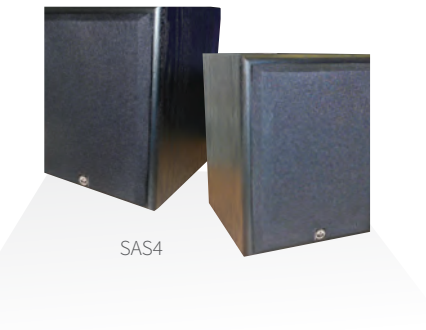

SAS4

2 WAY COMPACT SPEAKERS

Part No: 22-0231

- 2 Way plastic sealed box
- 3-1/2" Mica cone foam edge woofer
- 13mm PEI dome tweeter
- 120 Watts peak power
- 30 Watts RMS
- Frequency response: 75-22.000Hz
- H195 X W130 X D105

Part No: 22-0232

- 2 Way plastic sealed box
- 5" Mica cone rubber edge woofer
- 13mm PEI dome tweeter
- 160 Watts peak power
- 40 Watts RMS
- Frequency response: 65-22.000Hz
- H241 X W180 X D150

Part No: 22-0233

- 2 Way plastic sealed box
- 6-1/2" Mica cone rubber edge woofer
- 13mm PEI dome tweeter
- 220 Watts peak power
- 55 Watts RMS
- Frequency response: 50-22.000Hz
- H288 X W215X D170

Part No: 22-0234

- Impedance: 6 ohm
- 90 Watts peak power
- 60 Watts RMS
- Frequency response: 65hz - 20KHz
- H280 X W220X D170

- Cost efficient
- Made from strong, durable, impact - resistant plastic
- Stack easily, won't stick
- Available in 2 sizes
 - 300cc (D=100mm , h=60mm)
 - 500cc (D=115mm , h=70mm)

- 39-0540 Cupholder for 500cc cups x 500
- 39-0541 Cupholder for 300cc cups
- 39-0528 Good Luck Coin cup x 500
- 39-0529 300cc Coin Cup x 1000

CUSTOMISE YOUR CUPS

Just send us your logo and any ideas you might have and for a small set-up charge you can have your cups customised to your design



Redemption Tickets and Dispensers

REDEMPTION TICKETS

45-0400-2	Red
45-0400-3	Orange
45-0400-4	Yellow
45-0400-5	Green
45-0400-6	Blue

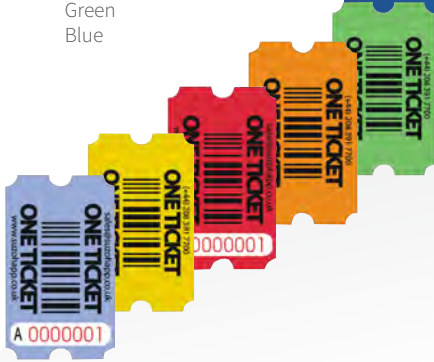

Tickets can be personalized to your requirements

ENTD-2000 TICKET DISPENSER

- Virtually eliminate ticket jams
- Requires very little maintenance
- One of the most reliable and compatible ticket dispenser on the market

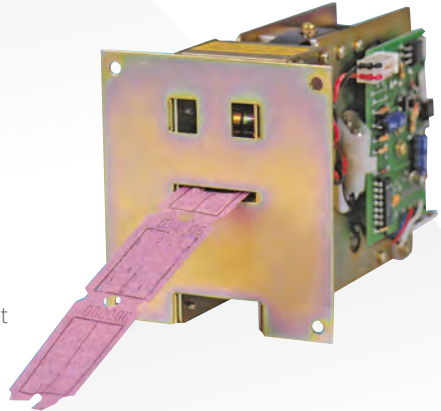

42-1337-00	Ticket Dispense
A070-1010-00	PCB for Entropy Dispenser

DELTRONIC TICKET DISPENSER

- “Snap out” one ticket dispenser - replace it with another in seconds
- No tools necessary
- Foolproof braking system is easily adjustable
- Validation “Diamond” mark identifies tickets
- Available as Continuous or Pulse type

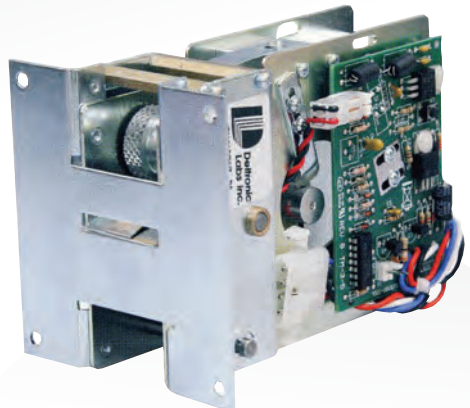

42-0544-00	Continuous
42-1547-00	Pulse
DL-1275	PCB for DL-1275

AIR HOCKEY PUCK TWISTER

- Available in 70mm and 80mm diameter
- 4 neon colours: orange, white, yellow and blue
- Colours light up when black light tube is used
- Customer logo available to order (minimum 1000 in one colour, one time tooling cost applicable)
- 70MM pucks

30-0070-3301	Orange
30-0070-4401	Yellow
30-0070-6601	Blue
30-0070-9901	White



AIR HOCKEY HAMMER

- Universal Hammer for all air hockey games
- Made of durable material
- High profile handle to prevent injuries

30-0041-6	Blue
30-0041-7	Pink



FELT DISC

- Replacement felt disc for Air Hockey Hammer 'Pro'
- Not suitable for BC1010-1

30-0030

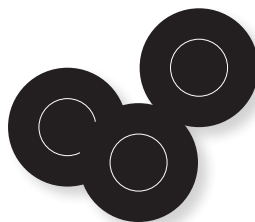

TOUCH SCREEN MALLET

22-1947-1

SMALL FOAM MALLETS

22-1949 Red & Yellow
22-1946-1 (longer cable 125cm)

UNIVERSAL MALLET

51-5000-00



'KICK IT' FOOTBALL & TETHER

AI0225 Tether
AI0189 Football



29" PUMP ACTION SHOTGUN FOR BICK BUCK HUNTER PRO

96-0476-13 29" Pump Action Shotgun, Green
96-0476-17 29" Pump Action Shotgun, Orange



JUMBO IPB WHITE. BLACK TRIM. RGB LED UFO Style

75-0029-00



JUMBO BUTTONS

Jumbo Circular Button White Legend Colour Lens

75-4002-10187 Red
75-4002-11187 White
75-4002-12187 Blue
75-4002-13187 Green
75-4002-15187 Yellow
75-4002-17187 Orange
75-0029-00NEW

BASKETBALLS

49-0471-00 – 7" Orange Basketball
49-0825-00 – 9" Orange Basketball
49-1264-00 – 7" Tri-Colour Basketball
49-3020-00 – 5.5" Multicolour Mini Basketball





MANY MORE AMBERSIL PRODUCTS AVAILABLE

Dry lubricant for smooth lock lubrication

A dry graphite lubricant for long lasting, smooth lock operation. The microscopic grains of graphite ensure good penetration and effective anti-seize lubrication.

Features

- Long lasting lubrication
- Dry film does not attract dirt and grime
- Excellent water resistance
- Wide operating temperature range
- Works even when lock has mild corrosion





'NEON' Glassfibre Pool Cue

- Almost unbreakable glass fibre pool cue
- no added weights that can go loose
- Moulded rubber grip
- 12 mm Slip-on tip
- Available in 4 different colours
- Length 140 cm - 57"
- Very competitive pricing!

47-0069 neon pool cue black
 47-0069-4 neon pool cue yellow
 47-0069-6 neon pool cue blue



Slip-on Tips

- Slip-on tips for the neon Glassfibre cues

47-1112 12 mm Push on tips

'MATRIX' Glassfibre Pool Cue

- Besides being almost unbreakable, these Cues look like a real maple Pool Cue
- Give your players a top quality cue which will last much longer than wooden cues
- Black handle with 4-prong look
- Fitted with 12mm plastic screw-on tip
- Length 140 cm - 57"

Matrix Pool Cue
 47-0085



Screw-on Tips

- Selected leather on quality plastic M8 thread with 12 mm tip used on most popular 1 piece cue

47-1230-6 12 mm Screw-on tip

'MAPLE' Pool Cue

- Maple pool cue
- Fitted with 12mm plastic screw-on tip
- 4-prong brown handle
- Black rubber screw-on bumper
- Weight approx. 550gr
- Length 140 cm - 57"

47-0083 Maple Pool Cue



Plastic Screw-on Tip 12mm

47-1230-6 Screw-on tip

Rubber Bumper

Screw-on-rubber bumper
47-1310 Rubber bumper

8-Ball 'MAPLE' Pool Cue

- Top quality maple pool cue
- Fitted with 13mm leather glue-on tip
- 4-prong brown handle
- 8-ball logo embedded in handle
- Assorted weights
- Length 140cm - 57"

26-1633-00 8 Ball Maple Pool Cue



"Elk Master" Glue-on Tips

- American made soft blue leather tips
- Made of special treaded leather
- Ensured grip and long life time

26-1073-13 Glue-on tip 13mm

Ash Snooker Cues

- Quality ash snooker cues
- Fitted with 9mm glue-on leather tip
- Available as 1 pc cue in 2 different colours or 2 pcs with brass joint
- Length 140cm - 57"

- 47-0155 1 pc tan butt
- 47-0156 1 pc dark butt
- 47-0273-9 2 pcs 57" Ash Cue
- 47-0273-48 2 pcs 48" Ash Cue

The Regent 2-Piece Pool Cue

Made of Ramin wood in robust design with a solid grip, brass joint, fitted with 11mm screw-on-tip and screw-on rubber bumper

- P4049 2-piece pool cue



"Elk Master" Glue-on Tips

- American made soft blue leather tips
- Made of special treaded leather
- Ensured grip and long life time

- 26-1073-9 Glue-on tip 9mm

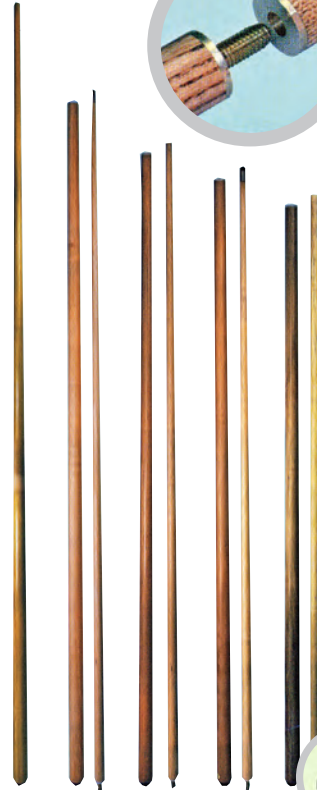
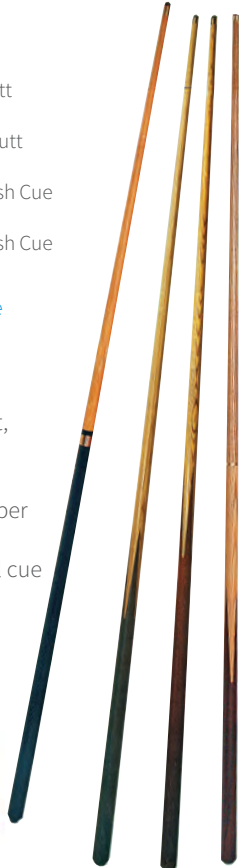

Ramin Rest Sticks and Long Cues

A complete range of rest stick, half butt cues and rests, long butt cues and rests.

- 47-0159 152cm - 60" Rest stick
- 47-0157-90 228cm - 90" Half butt cue
- 47-0157-108 275cm - 108" Long cue
- 47-0158-84 213cm - 84" Half butt rest
- 47-0158-96 244cm - 96" Long butt rest

Rubber Bumper

Screw-on-rubber bumper.

- 47-1310 Screw-on-rubber bumper

'The Shooter' Pool Cue

- Good quality ramin pool cue
- Fitted with 12mm plastic screw-on tip
- Carved black handle, painted in four prong look
- Black slip-on rubber bumper
- Sold in assorted weights
- Available in 4 different lengths

47-0052	140cm - 57"
47-0052-1	130cm - 52"
47-0052-2	120cm - 48"
47-0052-5	137cm - 54"
47-1230-6	Plastic Screw-on Tip 12mm
47-1320	Slip-on Rubber Bumper Rubber bumper



'The Regent' Pool Cue

- Good quality ramin pool cue
- Fitted with 11mm brass screw-on tip
- Black handle, painted in four prong look
- Black slip-on rubber bumper
- Sold in assorted weights
- Available in 6 different lengths

47-0050	140cm - 57"
47-0050-1	130cm - 52"
47-0050-2	120cm - 48"
47-0050-5	90cm - 36"
47-0050-6	137cm - 54"
47-0050-42	107cm - 42"
P2270	57" non-weighted cue
P0122	47" non-weighted cue

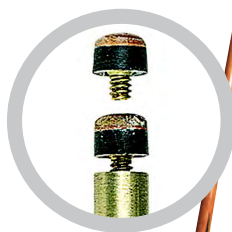

Brass Screw-on Tip

47-1240-4	Screw-on tip 11mm
-----------	----------------------

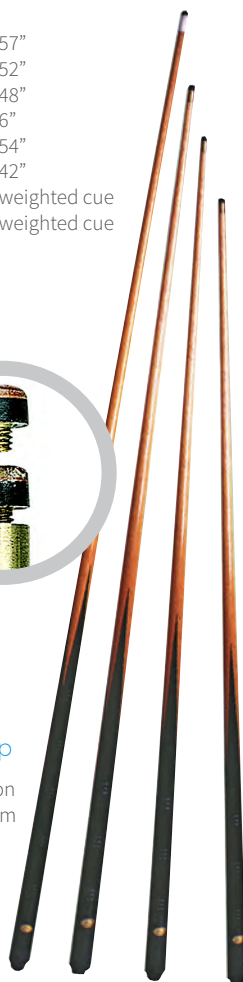



Push-on Tips

- Standard push-on tips with bonded pre-shaped tip
- Available in different sizes
- Sold in box of 100 pcs

47-1110	11mm
47-1111	11.5mm
47-1112	12mm
47-1113	12.5mm
47-1114	13mm
47-1115	13.5mm
47-1116	14mm

Billiard Pro Chalk

- Competitive price
- Sold in boxes of 12 pcs
- Available in red, green or blue



47-0650-2	Red 0.55
47-0650-5	Green 0.55
47-0650-6	Blue 0.55
47-0650-7	Purple 0.55

Triangle Billiard Chalk

- Top quality billiard chalk
- Sold in boxes of 12 or 144 pcs
- Available in red, blue or green

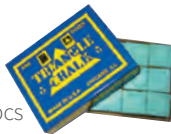

26-1023-12BT	Blue 12 pcs
26-1023-12RT	Red 12 pcs
26-1023-12GT	Green 12 pcs
26-1023-144BT	Blue 144 pcs
26-1023-144RT	Red 144 pcs
26-1023-144GT	Green 144 pcs

'Silver Cup' Billiard Chalk

- Strong, hard chalk grips cue tip for more accurate shooting
- Large range of colours
- Sold in boxes of 12 pcs or 144 pcs



26-1051-12B	Blue 12 pcs
26-1051-12G	Green 12 pcs
26-1051-12BK	Black 12 pcs
26-1051-12BUR	Burgundy 12 pcs
26-1051-12PW	Pewter 12 pcs
26-1051-12PR	Purple 12 pcs
26-1051-12R	Red 12 pcs
26-1051-12Tn	Tan 12 pcs
26-1051-12PNK	Pink 12 pcs
26-1051-12OLV	Olive 12 pcs
26-1051-12N	Navy 12 pcs
26-1051-12WN	Wine 12 pcs
26-1051-12SPR	Spruce 12 pcs
26-1051-144B	Blue 144 pcs
26-1051-144G	Green 144 pcs
26-1051-144R	Red 144 pcs
26-1051-144TN	Tan 144 pcs
26-1051-144BK	Black 144 pcs
26-1051-144PR	Purple 144 pcs
26-0194-00	Orange pcs
26-0568-00	White pcs
26-1051-12BRN	Brown pcs
26-1051-120P	Copper 12 pcs
26-1051-12EB	Electric Blue 12 pcs
26-1051-12PB	Powder Blue 12 pcs
26-1051-12PLM	Plum 12 pcs
26-1051-12RB	Royal Blue 12 pcs
26-1051-144BO	Burgandy 144 pcs
26-1051-144CM	Charcoal 144 pcs

'Master' Billiard Chalk

- Top quality billiard chalk
- Sold in boxes of 12 or 144 pcs
- Available in red, blue or green



26-1023-12R	Red 12 pcs
26-1023-12B	Blue 12 pcs
26-1023-12BLK	Black 12 pcs
26-1023-12G	Green 12 pcs



'Elk Master' Glue-on Tips

- American made soft blue leather tips
- Made of special treaded leather
- Ensured grip and long life time

26-1073-8	8mm
26-1073-85	8.5mm
26-1073-9	9mm
26-1073-95	9.5mm
26-1967-00	10mm
26-1073-11	11mm
26-1073-12	12mm
26-1073-13	13mm
26-1073-14	14mm



Blue Diamond Leather Tips

- Quality Leather cue tips
- Sold in boxes of 50
- Available in blue

47-2001	9mm
47-2002	10mm
47-2003	11mm
47-2006	14mm

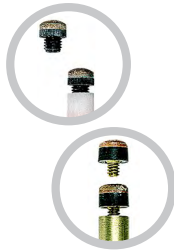

Screw-on Tips

- Available with plastic M8 thread in 12mm or 10/24 brass thread with 10, 11 or 12mm tip
- Sold in bags of 100

47-1230-6	12mm plastic thread
47-1240-2	10mm brass thread
47-1240-4	11mm brass thread
47-1240-6	12mm brass thread



Cue Tip Clamp Aluminium

- For easy replacement of cue tips
- Keeps pressure on the cue tip

47-1330 Cue tip clamp



Tip Fastener

- Keep pressure on the ferrule and tip
- Including compact file

47-1332 Tip fastener



Cue Tip Cement Tweeten

- Great for attaching leather tips to cues
- Will not harm leather tip
- Contents 2 oz / 57 grams

26-1107-00 Cement



Ferrules

- Various sizes plastic or brass ferrules.

47-1261-4 Brass ferrule 11mm
47-1265 Plastic ferrule M8 plastic thread



Snooker Ball Rails

- Sold per set of 6

47-0775 Ball Rails



Rapid Cue Top Sander

- Tool for precise preparing of the ferrule before replacing a cue tip

26-1103-00 Rue top sander



Sand Paper

- For use with the rapid cue top sander
- Sold per 10

47-0970-1 Sand paper



Slip-on Rubber Bumper

- Replacement rubber bumper
- Used on most standard pool cues

47-1320 Slip-on rubber bumper



Screw-on Rubber Bumper

- Replacement rubber bumper
- Screw mount (screw not included)

47-1310 Rubber bumper



Tip Trimmer

47-1080 Tip trimmer

Table Brushes

- Standard equipment for any pooltable
- Available in 23cm (9") or 30cm (12") size

47-1001-1 23cm (9") Brush
47-1001-3 30cm (12") Brush



Table Brush The Luxe

9" High quality brush

47-1002-1 9" brush The Luxe
47-1002-2 12 12" horsehair



Nylon Rail Brush

47-1010 Rail brush



Cue Cleaner

- Removes dirt and polishes the cue shaft

47-1395 Cue cleaner



Snooker Net

- Bag type. Sold per set of 6

47-0765-2 Snooker net





Chrome Cue Case for 2 piece Cue

P2231 Chrome Cue Case



Hard Cue Case for 2 piece Cue

47-0550 Hard Cue Case



SoftCue Case for 2 piece Cue

47-0549 CUE CASE Soft Cue Case



Foam Tube split Cue Case

47-0565 2 piece Cue Case



Hard Cue Case with 2 piece Cue

47-0273-90 2 piece Ash Cue & Case



Essex Straight Six Pool Mech

- This coin-mechanism is very selective thickness and diameter
- Very robust and highly flexible with respect to price-of-play change

47-0721-X Straight six
 47-0721-83 UK Industry New £1
 47-0721-81 Europe / Euro



Ratchet Spring and Pawl for Straight Six

47-0725 Spring and pawl



SS3228 Return Spring for Straight Six Old

47-0725-9 Return spring old



SS3228 Return Spring for Straight Six New

47-0725-9 NEW Return spring



Pool Table Battery Pack

- 15.6V non-rechargeable

E1168

Battery pack



Magnetic Chalk Holder

47-1055

Magnetic chalk holder



UK manufactured Dowsing Iron

- Thermostatically controlled with a temperature setting dial underneath the handle
- Supplied with a lead which is detached when ironing the table and a with a special stand on which to safely place the hot iron

47-0980



Simonis x-1 cleaning tool

- Removes chalk and dust on cloth
- Won't stretch or damage Cloth
- Non-slip handle for control
- Curved shape allows access to cloth underneath rails

P7065



Rubber Chalk Holder

- Rubber holder protects chalk from damage
- Prevents chalk from being taken away

47-1050-2 Rubber chalk holder

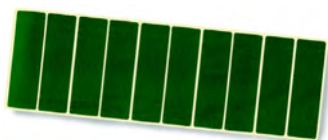

Cloth Plasters

- Bag type. Sold per set of 6

47-1305 Cloth plasters

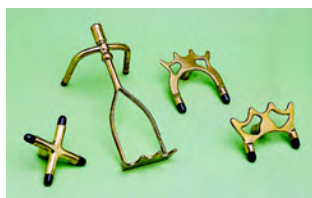

Brass Bridge Heads

47-1030 X bridge head
 47-1030-1 Long bridge head
 47-1030-2 Butt
 47-1030-3 Spider
 47-1030-4 Brass Swan
 47-1031 Plastic tip



Brass Heads

- Sold without toes

P5670 X rest
 P5671 Butt rest
 P5672 Spider rest



Chrome Bridge Heads

- Available as X rest or spider rest

47-1030-8 X rest chrome
 47-1030-9 Spider rest chrome



Black Plastic Pool Triangle

These high-impact, durable plastic triangles are economical and well designed for proper ball racking.

47-0700-1 15 balls 2-1/4"
 47-0700-3 15 balls 2-1/16"
 47-0700-4 15 balls 2"
 47-0700-5 10 balls 2"



Ball Tray

47-0710 Ball tray 16 balls
47-0710-1 Ball tray 22 balls



Oak 9-Ball Diamond

- For 2-1/4" balls

47-0703-2 Oak 9-ball triangle



9-Ball Diamond Triangle

- For 2-1/4" balls

47-0703-1 9-ball diamond



9-Ball Triangle

- For 2-1/4" balls

47-0700-6 9-ball triangle

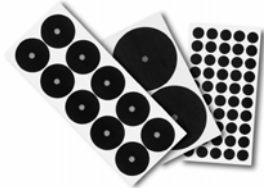

Pressure Sensitive Spots

- Marking points for pool billiard
- Black textile with spot in 3 different sizes: 12, 35 and 62mm

47-1300-12 12mm spot, per 5
47-1300-35 35mm spot, per 5
47-1300-62 62mm spot, per 5



Pool Table Cover

- For 6ft table, With fitted elastic band

47-0747 Table cover

Economy Green Cover

47-0740 7 ft
47-0745-1 8 ft
47-0742 9 ft
47-0743 10 ft
P2232 12 ft



Heavy Duty Cover, Black

47-1524 7ft Table
47-1525 7ft Table

Corner Cue Stand

- Oakwood finish cue-stand
- Holds 8 cues
- Top-shelf has cork liners for ashtray and 4 glasses
- Height ca 60cm

47-0502 Corner Cue Stand



Pro-Wheeler Cue Rack

Plastic Cue Rack for 6 Cues
47-0505-3 Pro Wheeler Cue Rack



Riva Cue Stand

- The low boy cue-rack, has walnut hardwood finish
 - Holds 8 cues
 - Height ca 83cm
- 47-0501 Riva Cue Stand

12 Cue Heavy Duty Metal Rack

- 18 gauge steel
- Baked on black powder coating
- Smooth rolled holes

24"(H) x 14"(W) x 11"(D)
Weight 14 lbs

26-1461-00 NEW part number



Cue-Rack

- Wooden cue-rack for 4, 6, or 8 cues
- Solid construction with black flexible plastic cue clips
- Can be mounted to hold cues at centre up to 12" below tip

47-0507 6 Cue - rack
47-0507-1 4 Cue - rack
47-0507-2 8 Cue - rack



17 Cue Metal Floor Rack

- Heavy duty - made from 1/4" steel rod
- Base - 11-3/4" x 11-3/4" Height - 24"
26-1977-00 NEW part number

Black 2 piece Cue Rack

• Holds 6 cues
47-0509 Cue Rack



12 cue metal floor rack

Attractive black wrinkle powder coat metal finish with heavy duty brushed metal supports.

26-1105-00 NEW part number



Cue Clip

Black cue clip holds cues without marring.
47-1385-1 Plastic cue Clip



2" - 50.8mm Pool Ball Sets - 1-7/8" -48mm cue ball

- 47-0822 2" Spots and stripes
- 47-0842-1 2" Reds and yellows
- 47-0842-BY 2" Blues and yellows



Snooker Ball Sets

- 47-0893 2-1/16" 22 balls
- 47-0842-Sn 2" 17 balls

Pool Balls 2" - 50.8mm

- 47-0802-2 Red ball 2"
- 47-0802-4 Yellow ball 2"

2-1/4"-57mm Crazy 8 Ball

- Have fun with these crazy 8 balls
- Never follow the desired direction

- 47-0090 Crazy 8 ball

Cue Balls

- 47-0801-9 1-7/8"
- 47-0802-9 2"
- 47-0804-9 2-1/8"
- 47-0805-9 2-1/4"
- 47-0806-9 2-3/8"



2-1/4" - 57mm Pool Ball Sets Spots and Stripes

- 47-0845 2-1/4" with cue ball



2-1/4" - 57mm Pool Ball Sets Reds and Yellows

- 47-0845-1 2-1/4"-with cue ball



8 Balls

- 47-0812-8 8 Ball 2"
- 47-0815-8 8 Ball 2-1/4"



Pool Magnetic Cue Ball

- Used in various pooltable brands like Valley and others

- 47-0807-9 Magnetic

Table Lighting



Billiard Lamp "Nostalgia"

- These decorative 3-pieces billiard lamps are available with a brass or chrome bar and fittings. Mounting hardware included
- Available in the following colours: red, green, blue, brass and chrome
- Overall length approx. 120cm
- Fittings are for use with bayonet lamps (not included)
- Shades and bars are supplied separately

P5654	3-way brass bar and fittings
P5663	3-way chrome bar and fittings
47-0030-2	Red bowl shade
47-0030-5	Green bowl shade
47-0030-6	Blue bowl shade
47-0030-C	Chrome bowl shade
P2220	Brass bowl shade
47-1480-1	Chain (gold)



Refurb Accessories

POOL REFURB KIT Everything you need for your pool/billiard table!!

- 1 set Bed & Cushions 7x4
(Red, Green or Blue)
- 1 set balls (R&Y or B&Y)
- 1 Box Chalk (Red, Green
or Blue)
- 1 12" Brush
- 1 Cloth Cleaner
- 1 Cloth Adhesive
- 1 Plastic Triangle for 2" balls
- 1 Pool Rules Sheet

- REFURB-KIT-RED
- REFURB-KIT-BLUE
- REFURB-KIT-GREEN

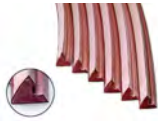

Rubber Cushion

- Moulded pure gum rubber
- Sold in set of 6 pcs
- With linen protector
- Responsive cushion - attracts players

47-0761 Rubber 48" - 122cm



Economy L Shaped Rubber

- 183cm (72") length. Pink
- 47-0764 L shaped rubber pink



Club L Shaped Rubber

- 183cm (72") length. Black
- 47-0764B L shaped rubber black



Paste on Pool Table Adhesive

- Available in 1 and 5 litre tubs

E9787 1 litre tub
E9786 5 litre tub



Gully Boots

- Used for pool billiard
- Colour black
- 6 pcs per set

47-0756 Gully boots



Pocket Liner for Pool Table

- Colour black
- 6 pcs per set
- 4 corners and 2 sides
- Available in rubber and vinyl, 3 and 4 "

47-0750 3" (rubber)
47-0750-1 4" (rubber)
47-0750-2 4" (vinyl)



Pool and Snooker Cloth Cleaner

Removes chalk and light contamination from snooker and pool table cloth

- Contents: 400 ml
- 20-0084 Cloth Cleaner



Pool and Snooker Cloth Adhesive High strength adhesive with longer open bond time for large surface areas

- Tack time: 2-10 minutes
- Contents: 500 ml
- Ambersil HS300

20-0100 HS 300
20-0082 NC 500
20-0075 QS 900



Pocket Liner Screw

- Sold in packs of 50

P1139 1 Screw



D Marker

P5055 D Marker



Pool Table Marker Pen

47-0700 Marker Pen



P4001 Notice Board, Superleague Pool

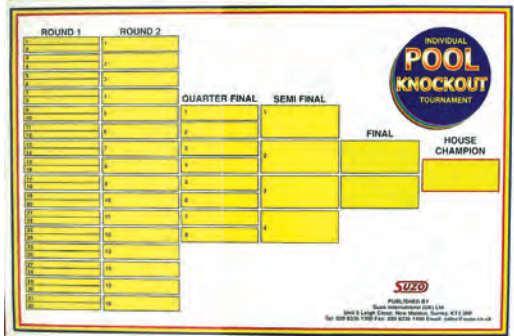

P4088 Pool Knockout Sheet (Pk 10)



POOL RULES - Pool Rules



Scoreboard for 2 Players
47-0603 Scoreboard



Scoreboard for 4 Players
P2250 Scoreboard

Take advantage of our on-site
cloth cutting service
ANY CLOTH! ANY COLOUR! ANY SIZE!



The Strachan range of fine billiard and snooker cloths offer products of the highest quality, providing players with the ultimate high performance playing surface characterised by a crisp, highly engineered nap with a lustrous finish, consistent colour and high durability.

Snooker Cloth 100% wool

1032-GR	number 10 Championship cloth 1 meter 30 oz
P5965-Sn	Full Size number 10 Bed and Cushion
6811GO-GR76 6811	(Tournament) 1 meter. 30oz
6811-Sn	GO Full Size Snooker Gold bed & Cushion pack
6811-Sn	GOB Full Size Snooker Gold bed only
6811-Sn	GOC Full Size Snooker Gold cushion only
10X5PK6811	GOSn 6811 Gold 10 foot Snooker
9X5PK6811	GOSn 6811 Gold 9 foot Snooker

Also available in other lengths

6811SI-GR76 6811	Club 1 meter. 29.5oz
6811-SnSI	Full Size Snooker Silver bed & Cushion pack
6811-SnSIB	Full Size Snooker Silver bed
6811-SnSIC	Full Size Snooker Silver cushion

Also available in other lengths

6811 Pool Cloth - CLUB

- 100% wool
- With Spillguard
- Weight 29oz @ 86"

6811-GR86	6811 Pool Green cloth 1 meter 86"
6811-BL86	6811 Pool Blue cloth 1 meter 86"
6811-Bu86	6811 Pool Burgundy cloth 1 meter 86"
6811-RE86	6811 Pool Red cloth 1 meter 86"
6811-BLK86	6811 Pool Black cloth 1 meter 86"

Available in 6x3, 7x4, 8x5,9x5 cut packs

Part number = XXXPACK6811YYY

6811 Pool Cloth - TOURNAMENT

- 100% wool
- With Spillguard
- Weight 29oz @ 86"

6811GO-GR86	6811 Pool Green cloth 1 meter 86"
6811GO-BL86	6811 Pool Blue cloth 1 meter 86"
6811GO-Bu86	6811 Pool Burgundy cloth 1 meter 86"
6811GO-RE86	6811 Pool Red cloth 1 meter 86"
6811GO-BLK86	6811 Pool Black cloth 1 meter 86"

Available in 6x3, 7x4, 8x5,9x5 cut packs

Part number = XXXPACK6811YYY



6811 Tournament Cloth

- 100% wool
- With Spillguard
- Tournament cloth available in 63"
- Weight 14.5 oz

6811-GR63	6811 Gold 63" 1 meter Green
6811-BL63	6811 Gold 63" 1 meter Blue
6811-Bu63	6811 Gold 63" 1 meter Burgundy
6811-RE63	6811 Gold 63" 1 meter Red
6811-Pu63	6811 Gold 63" 1 meter Purple
6811-BK63	6811 Gold 63" 1 meter Black

Available in cut packs

777-GR85	777 85" Green
777-BL85	777 85" Blue
777-PuR85	777 85" Purple
777-RE85	777 85" Red
777-BLK85	777 85" Black
777-BuR85	777 85" Burgundy

All of above available in 6x3, 7x4, 8x5, 9x5 cut packs

Part number 777-XXX-YY
(XXX= pack size 6x3,7x4,8x5 or 9x5 -
YYY= Colour code)

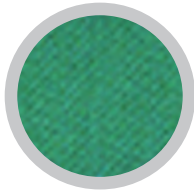

Yellow Green

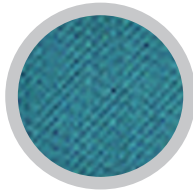

Blue Green

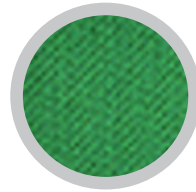

English Green

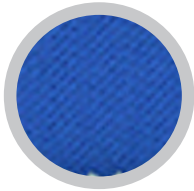

Royal Blue

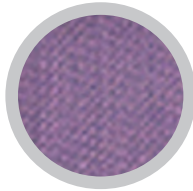

Powder Blue

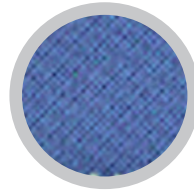

Electric Blue

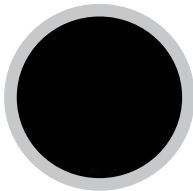

Black Navy

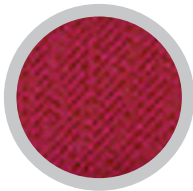

Burgundy

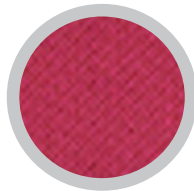

Red Violet

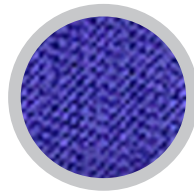

Violet

Eurospeed Billiard Speed Cloth

- Weight 630gr per running meter
- Width 63" (also 79" available for English green only)
- 45% wool 65% nylon
- Offering to our customers a good quality range of speed cloth at an excellent price
- Sold per meter or pre-cut packs for 6x3, 7x4, 8x5 or 9x5 Packs

Part numbers Colour

P5093	Eurospeed yellow green 63" - 1mtr
P5094	Eurospeed powder blue 63" - 1mtr
P5095	Eurospeed purple 63" - 1mtr
P5096	Eurospeed royal blue 63" - 1mtr
P5097	Eurospeed English green 63" - wide
P5098	Eurospeed red 63" - 1mtr
P5099	Eurospeed burgundy 63" - 1mtr
P5100	Eurospeed US blue green 63" - 1mtr
P5101	Eurospeed black 63" - 1mtr
P5097-200	Eurospeed English green 79" - wide

Part numbers PXXXX-YYY
 (PXXXX = Cloth part no YYY = pack size,
 for example 6x3)

SuperPro Speed Cloth

SuperPro™
Professional Cue Sports Cloth

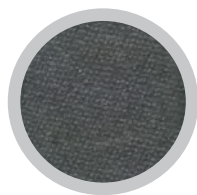

Black

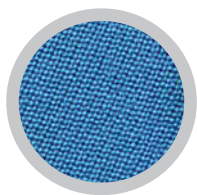

Tournament blue

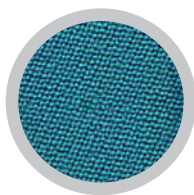

American
Yellow Green

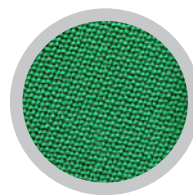

American
Blue Green

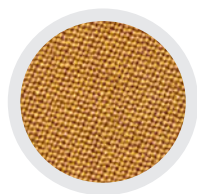

Tan / Camel

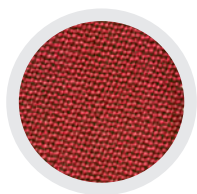

Burgundy

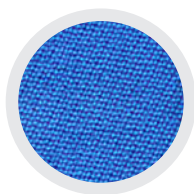

Electric Blue

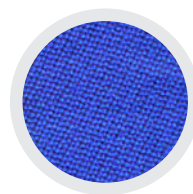

Blue

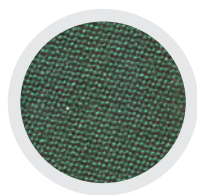

Green

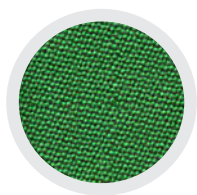

American Yellow
Green

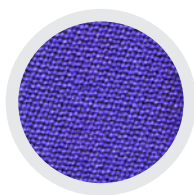

Purple

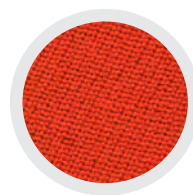

Red

- Speed Cloth
- Spillguard finish
- 30% nylon / 70% Wool
- Supplied in 78" width in a variety of colours
- Sold per meter or cut packs

Cut Packs Sold in 6x3, 7x4, 8x5 and 9x5

Part number = SPRO-XXX-YY
(XXX= pack size 6x3, 7x4, 8x5 or
9x5 - YYY= Colour code)

Part numbers

Colour

SPRO-BLK78	Black
SPRO-BL78	Blue
SPRO-Bu78	Burgundy
SPRO-EB78	Electric Blue
SPRO-TB78	Tournament Blue
SPRO-GR78	Green
SPRO-YG78	American Yellow Green
SPRO-BG78	American Blue Green
SPRO-RE78	Red
SPRO-Pu78 29.75	Purple
SPRO-CAM78 29.75	Tan/Camel

Artscape™ is high definition, digital imaging onto premium grade, spill protected pool table cloths.

Using our expertise and leading edge technologies we print unique, photo realistic designs coordinated across the bed and cushion rails. Artscape™ imaging is available on cloth made for both American and English pool. All our fabrics are manufactured to the highest quality and durability.

We have over 100 years experience in the manufacture of pool and snooker cloths. We possess the unique ability to process the printed cloth through our finishing technology to achieve the perfect playing surface whether this is a fine worsted or a fine napped finish.

Artscape pool cloths can increase table revenue by up to 40% and offer the complete solution; each is made to measure, individually packaged and easy to fit.

Our designs do not affect cloth performance or play characteristics and maintain cloth appearance for longer by minimising the effects of wear.



Pool & Snooker Balls

Saluc produces and distributes billiard balls under the registered trademark Aramith in more than 85 countries, and has a market share of 80% worldwide. The company is also specialised in the production of industrial balls used in all kinds of applications, as well as in 9 pin bowling balls and trackballs. Export represents 98% of its activity. One of the major strengths of the company is its upstream integration: Saluc has its own chemical plant, which produces the phenolic resin which gives the exceptional characteristics to the finished products. This integration allows the price optimization and quality insurance. The Aramith phenolic balls last up to five times longer than other balls made of polyester," said Yves Bilquin, sales and marketing manager for north America and previously the R&D manager. SUZOHAPP is a distributor and stockist of Aramith products, the full range is available although some of the less standard items may require lead times and stock.

47-0100	Aramith Crazy Cue ball 2-1/4"
47-0108	Sapro Striped 8 Ball
47-0809	Aramith 2" Cue Ball Premier
47-0098	Aramith micro fibre cloth
47-0099	Aramith 2-1/4" TV Spots and stripes
47-0610	Aramith 2 1/4" S & S Premium
47-0610-1	Aramith 1-7/8 S&S Premier
47-0610-2	Aramith 2-1/16 S&S Premier
47-0611	Aramith 2" 1-7/8 S & S Premium
47-0613	Aramith 2" 1-7/8 S & S Standard
47-0611-1	Aramith 2" R & Y 1-7/8" Premium
47-0613-1	Aramith 2" R & Y 1-7/8" Standard
47-0611-2	Aramith 2" B & Y 1-7/8" Premium
47-0611-3	Aramith 1-7/8 R-Y Premier
47-0615-8	Aramith 2" Black Ball no.8
47-0616-8	Aramith 2 1/4" Black Ball no.8
47-0616-9	Aramith 1 7/8" Cue Ball white Premier
47-0617-9	Aramith 2 3/8" Cue Ball white Premier
47-0618-9	Aramith 2 1/4" Cue Ball white Premier
47-0619-9	Aramith 2 1/16" Cue Ball Premier
47-0620-1	Aramith 2 1/16" snooker set
47-0620-2	Aramith 2"+ 1-7/8" snooker set
47-0620-3	Aramith 2" 17 Ball snooker set

47-0620-4	Aramith 2-1/4" 22 Ball snooker
47-0620-5	Aramith 1-7/8" 17 Ball snooker
47-0620-6	Aramith 1-1/2" 17 Ball Snooker
47-2010	Aramith 1-3/4" 17 Ball Snooker
47-0620-9	Aramith magnetic 2 1/4" Cue Ball
47-0630-1	Aramith 2-1/4" Granite set
47-0630-3	Aramith 2-1/4" Red logo Cue Bal
47-0630-7	Aramith bar billiard set 1-7/8
47-2007	2-1/16" Tournament Championship snooker set
47-2008	STC 2-1/16" R/Y/W Billiard
47-2009	Sapro R&Y with Striped 8 ball set
47-2009-1	Sapro Cup R & Y 2" nylon case set
47-0088	Aramith super 2-1/4" pro-cup
47-0089	Aramith Golden 8 Ball
47-0090	Aramith Crazy 8 Ball
47-0091	Aramith Ball cleaner
47-0092	Aramith Ball restorer
47-0093	Aramith 1-7/8" Pro cup Cue Ball Premier
47-0096	Aramith 2-1/16" Pro cup Cue Ball Premier
47-0097	Aramith 2-1/4" Pro cup Cue Ball Premier
47-2011	Aramith Tournament Champion 2-1/16" Cue ball
47-2012	Aramith Glow-in-the Dark 2" Home Kit
47-2013	Aramith Glow-in-the Dark 2-1/4" Home Kit





Hydro Trolley

- Hydraulic
- Pool Table Trolley
- Maximum lifting weight 600 Kg

P7999

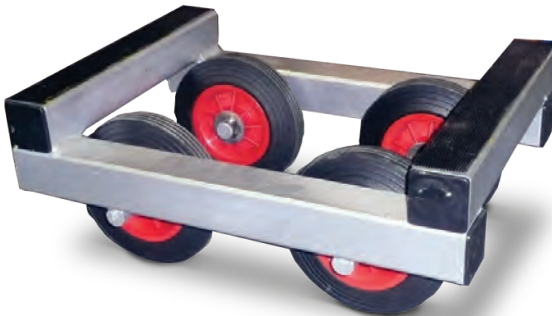

Piano Trolley

Maximum lifting weight 600 Kg

P0142

Hydraulic Lifting Table

- Rugged construction
- Polyester powder coated hammer grey
- Large wheels for easy manoeuvrability under load
- Foot pedal operation
- Non-removable handle
- Unladen weight 26Kg

P7501

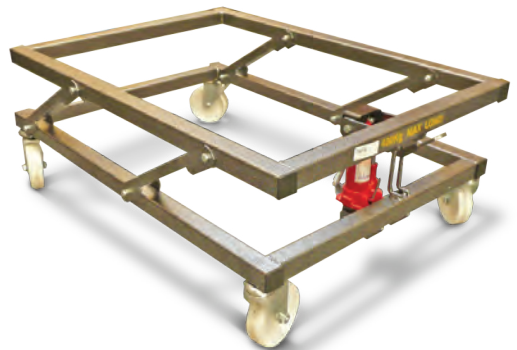



REPAIR AWARE?

Coin Acceptors *
Note Acceptors *
Power Supplies *
Sega / Namco Game Boards *
Scorpion 4 & 5 MPU *
LCD Monitors / Touchscreens *
Free Collection & Return **

Offer valid for UK customers only

* Contact our Sales Team for more info on 0208 391 7700
or sales@suzohapp.co.uk for details

** Minimum 5 items per collection / Average 7 day turnaround / Excludes Northern Ireland / ROI &
Certain UK Postcodes, collection / delivery by UPS.



Suzo International (UK) Ltd

Unit 1, King Georges, Trading Estate, Davis Road
Chessington - Surrey KT9 1TT

Tel: +44 020 8391 7700 - Fax: +44 020 8391 7760
sales@suzohapp.co.uk - suzohapp.com